

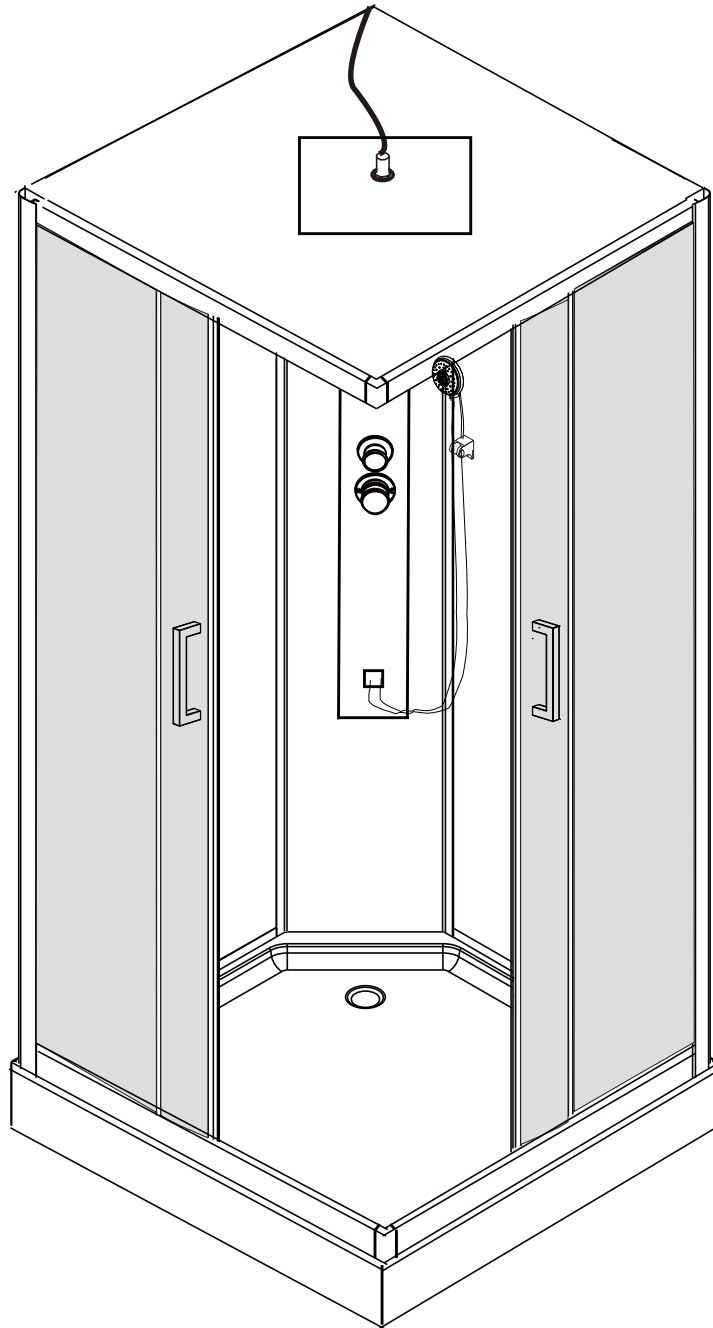

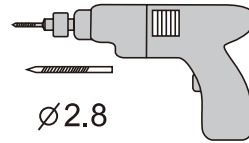

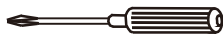

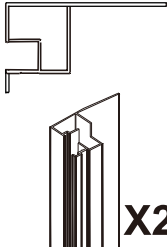





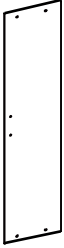
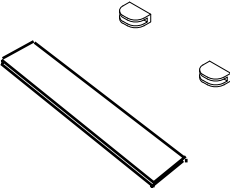

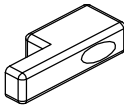
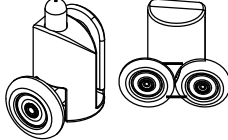

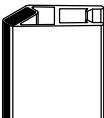
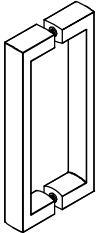
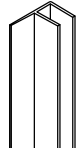
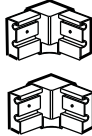
AMI Quadro

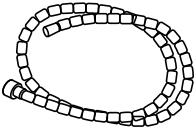
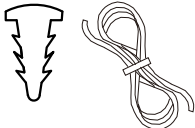
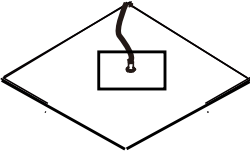

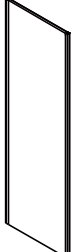
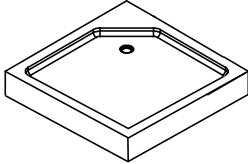

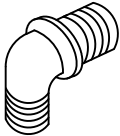
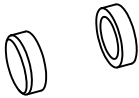
 A1 X2	 A2 X2	 A3 X2	 A4 X2	 A5 X2
 A6 X1	 A7 X1	 A8 X4	 A9 X8	 A10 X2
 A11 X2	 A12 X2	 A13 X2	 A14 X2	 A15 X1
 A16 X1	 A17 X2	 A18 X1	 A19 X1	 A20 X1
 A21 X2	 A22 X1	 A23 X4	 A24 X1	 A25 X1
 A26 X1	 ST4X8=4 ST4X50=8 ST4*12=32 ST4X12=4 M4*25=7			

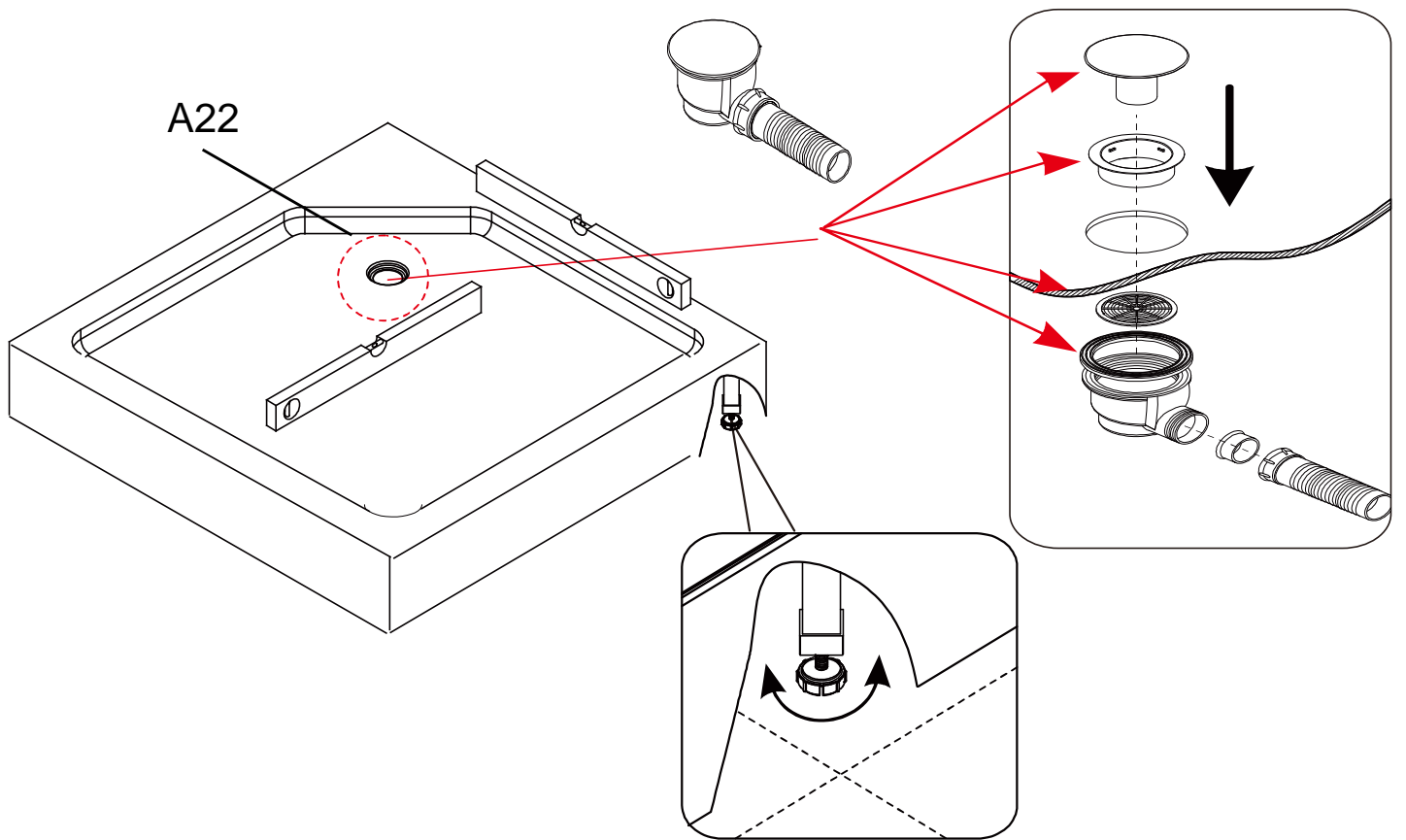

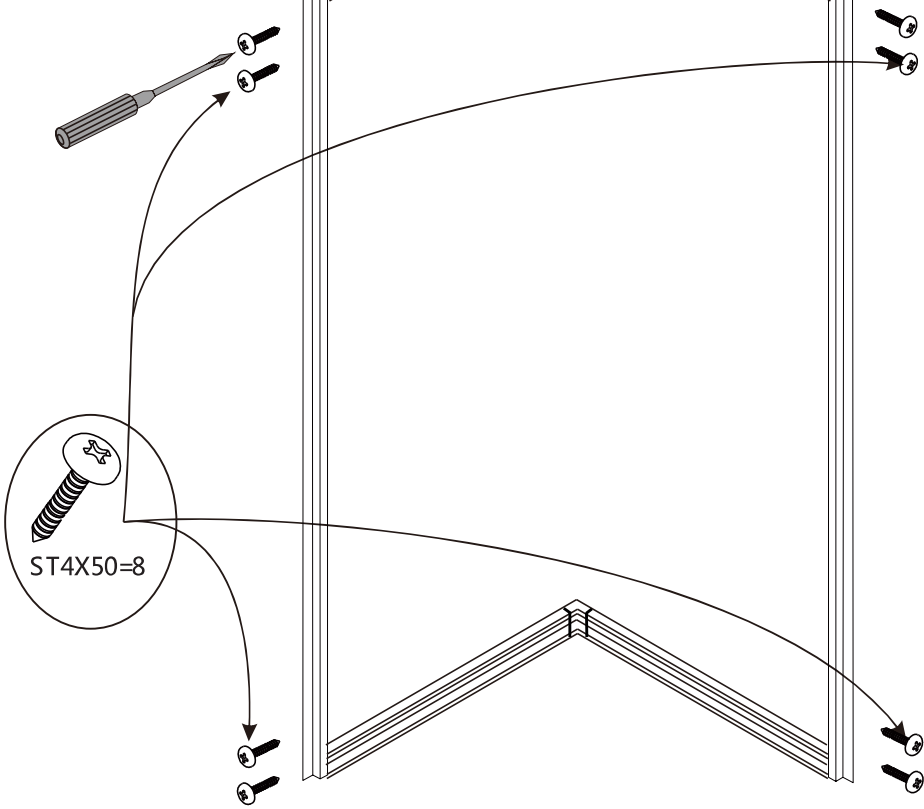
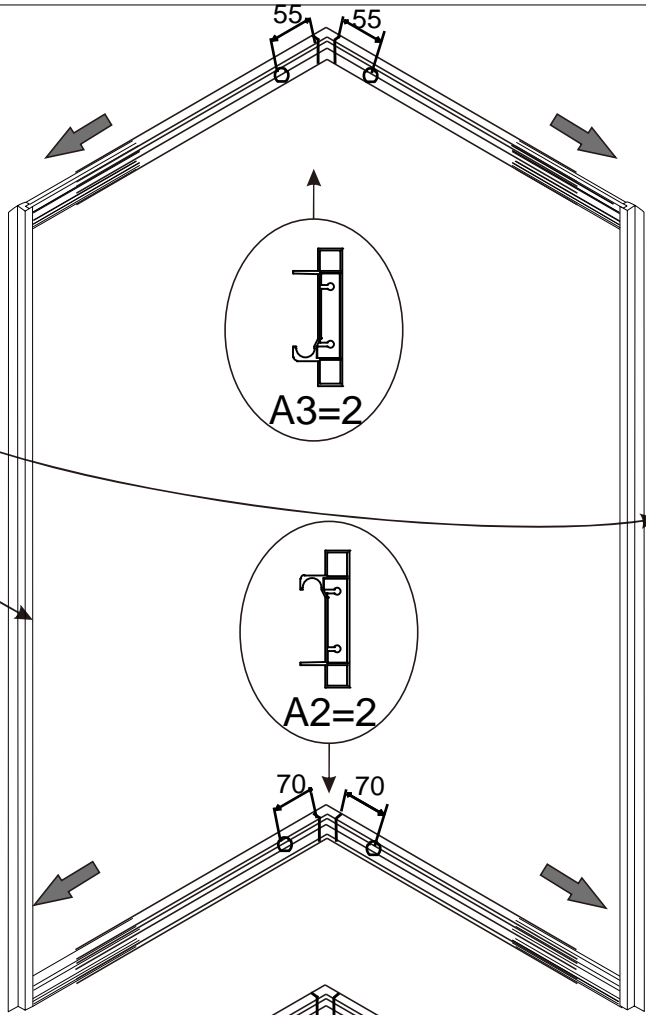
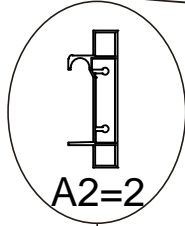
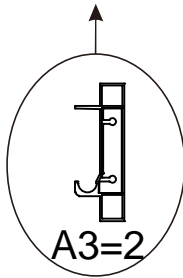
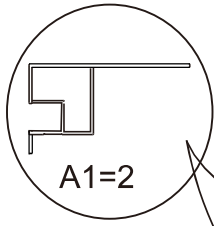

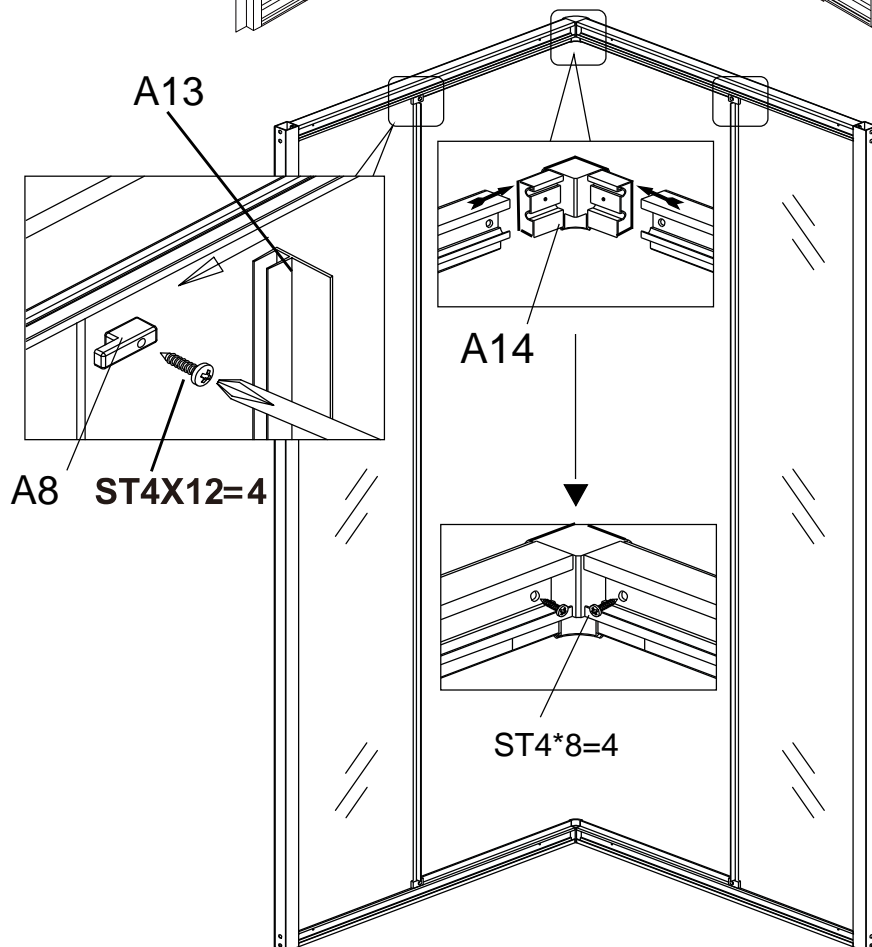
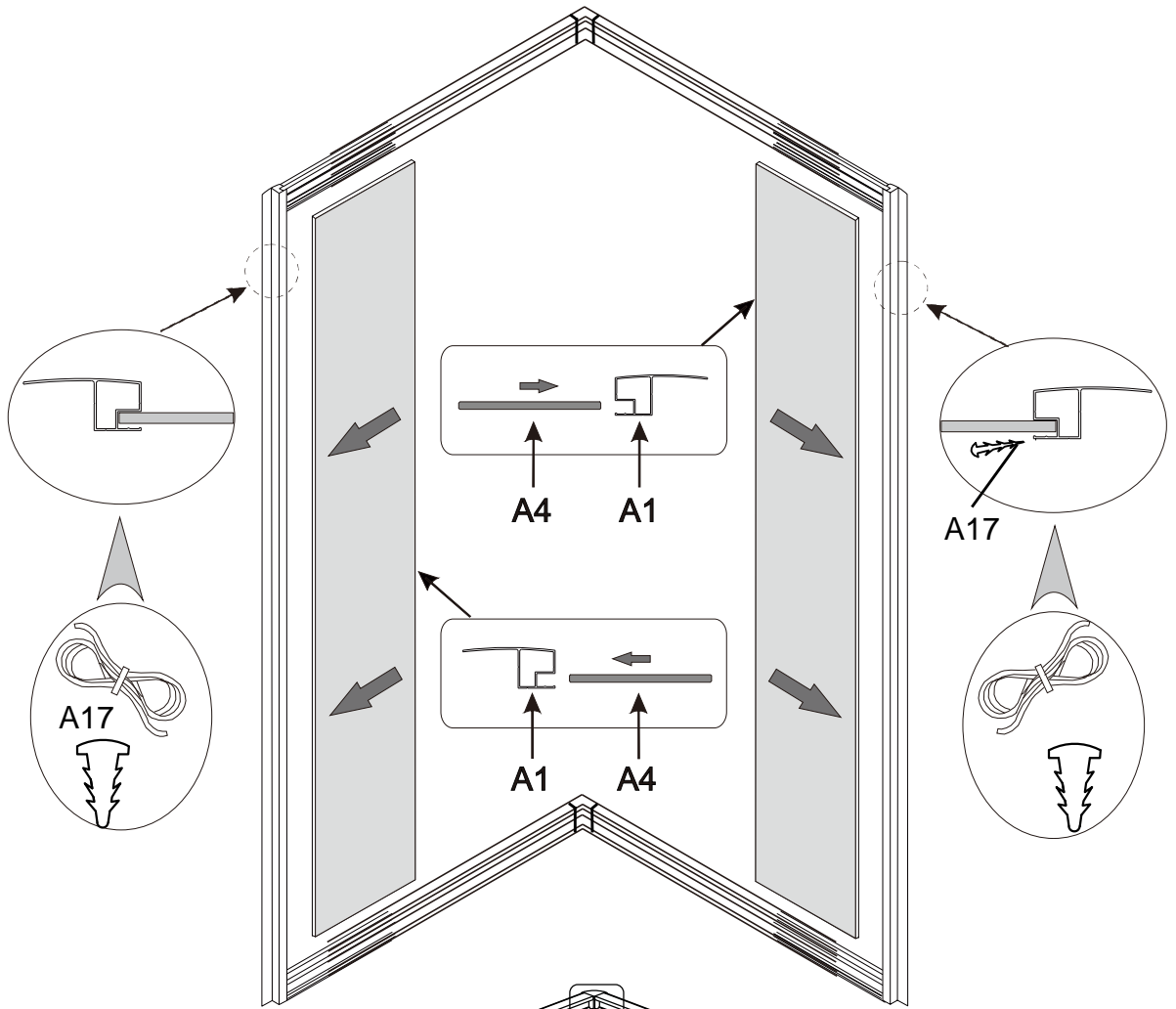

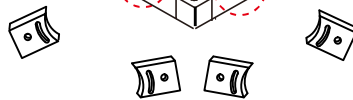
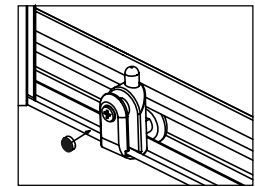
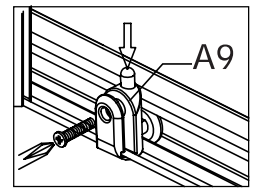
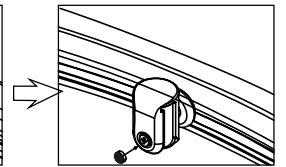
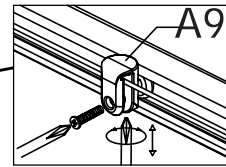
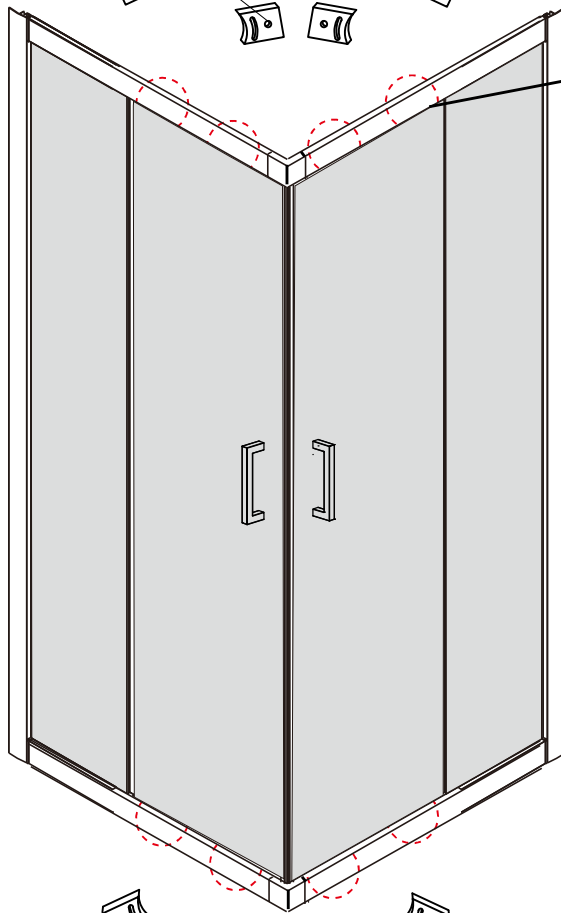
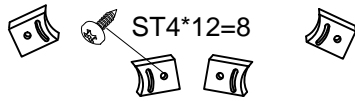
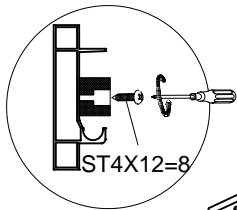
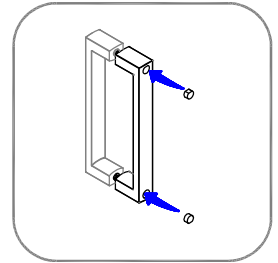
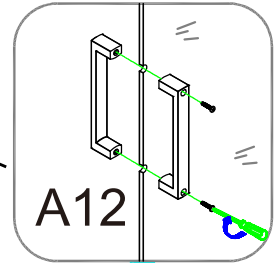
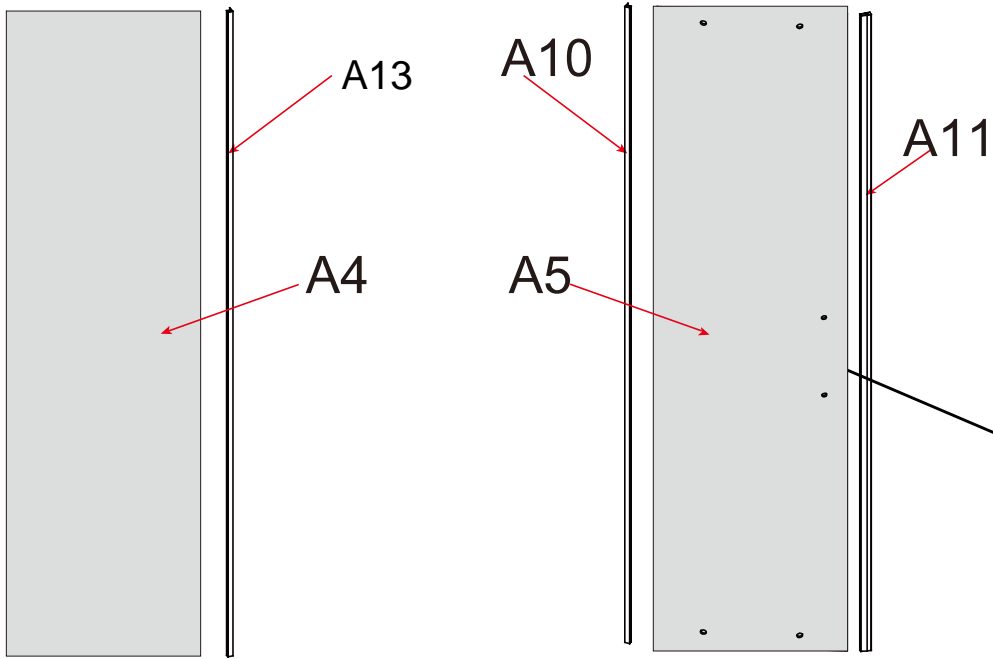

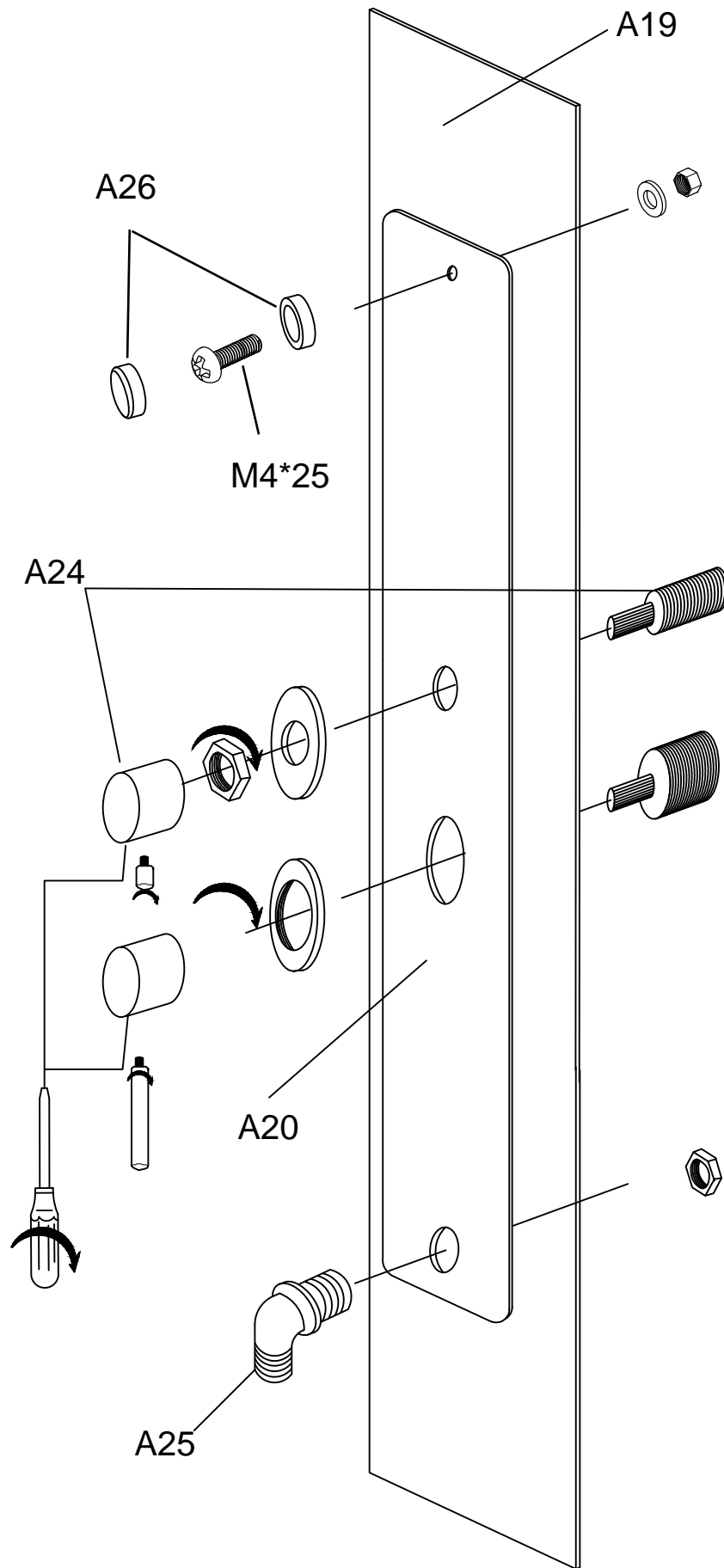

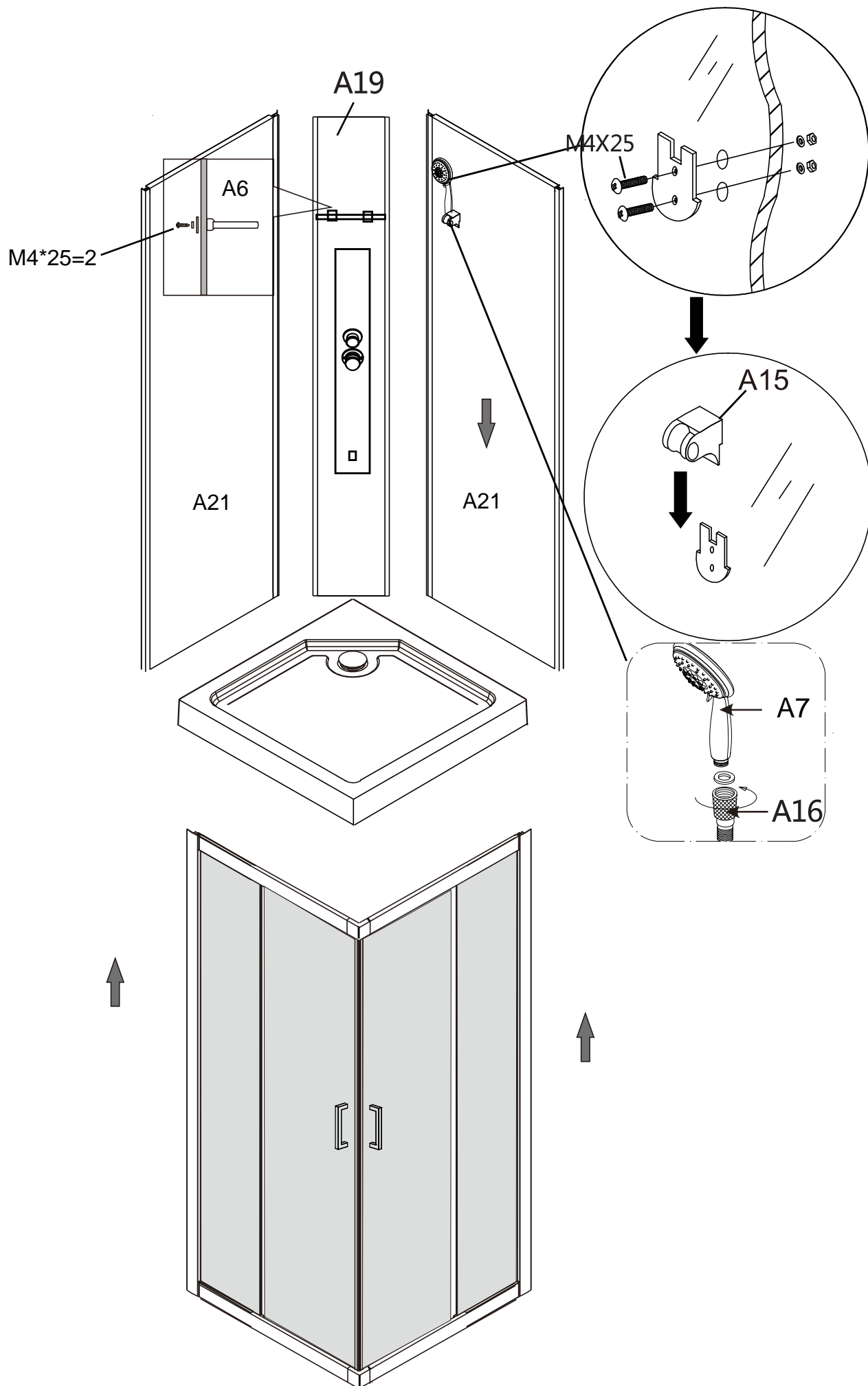

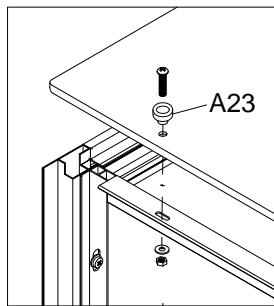

M4X25=4



ST4X12=4

