

# Installation Manual

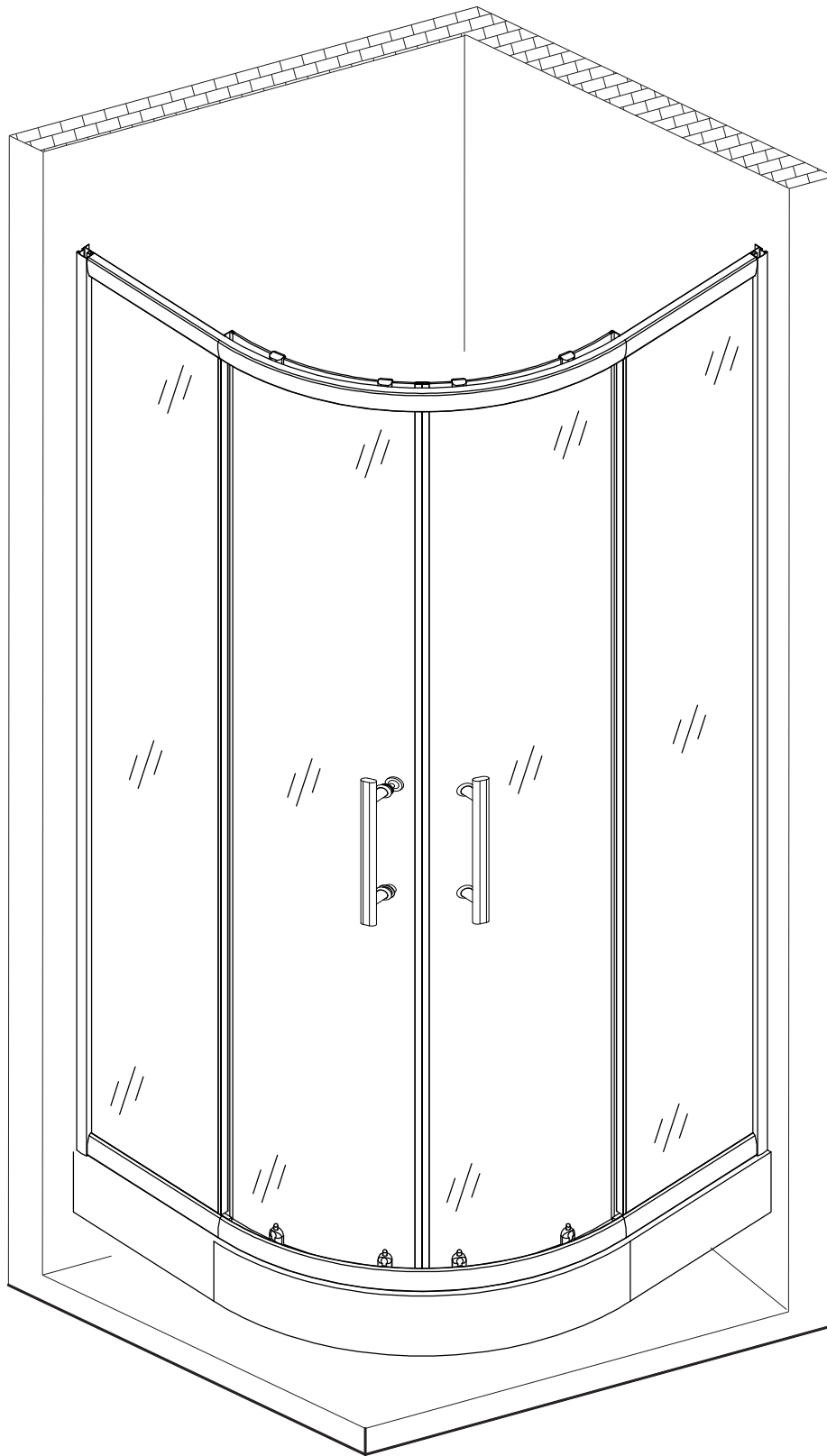







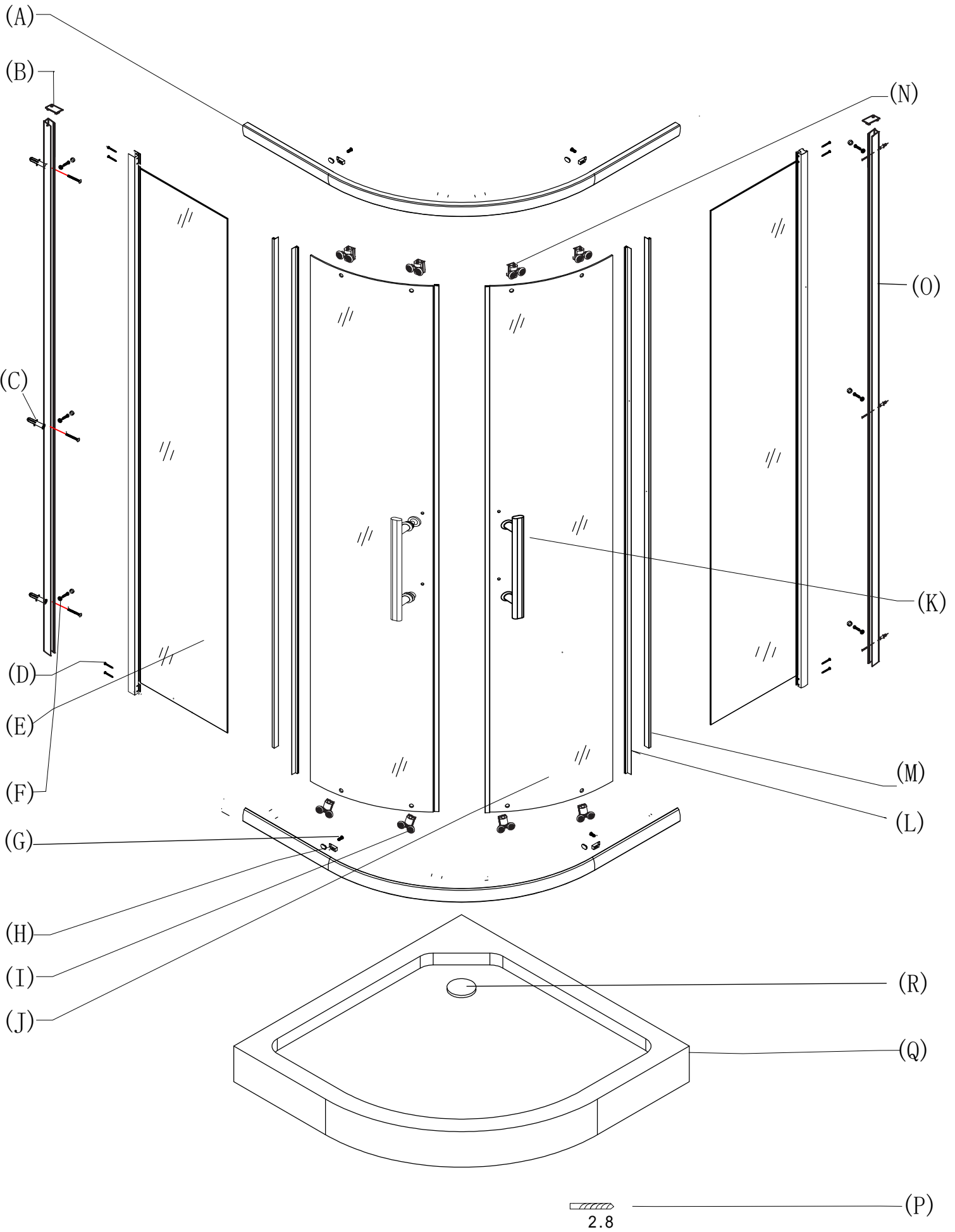

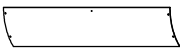







**MODEL: ESD-8005 / ESD-8015**

**SIZE: 800\*800\*2000MM**

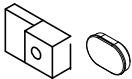
**900\*900\*2000MM**



A		2	J		2			
B		2	K		2			
C		6	L		2			
D	 ST4*35	14	M		2			
E		2	N		4			
F		6	O		2			
G	 ST4*10	10	P	 2.8	1			
H		4	Q		1			
I		4	R		1			

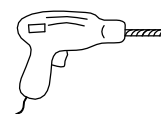
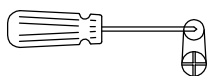
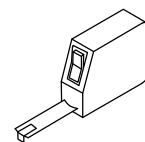
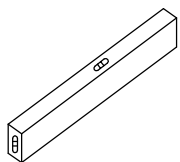

Ø6

